

DATA SHEET

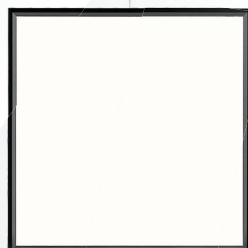

LED BACK-LIT PANEL

60×60 BLACK FRAME 3CCT SWITCH

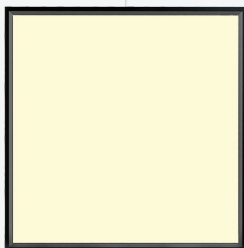

AVAILABLE MODELS

| Color Temp | REF No |
|------------------------|--------|
| 3000K, 4000K, 6000K | 907460 |

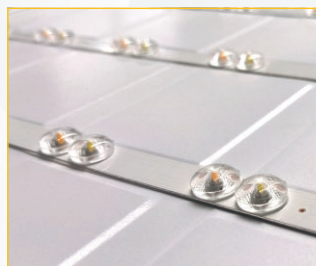
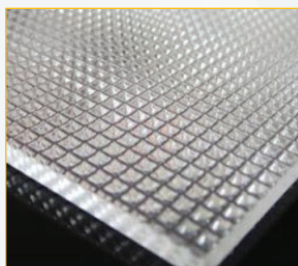
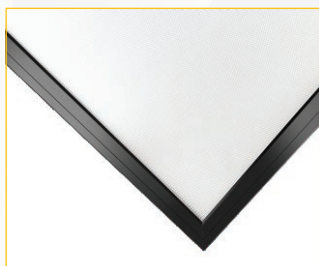
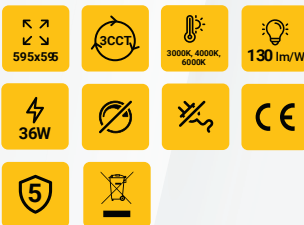

DATA SHEET



LED BACK-LIT PANEL 60×60 BLACK FRAME 3CCT SWITCH

ELECTRICAL DATA

| | |
|-----------------------|----------|
| Wattage (Consumption) | 36W |
| Voltage | 200-240V |
| Max. Current | 0.3A |
| Operating Voltage | DC36V |
| Constant Current | 900mA |
| Power Factor | ≥0,95 |

PHOTOMETRICAL DATA

| | |
|-----------------------------|---|
| Temperature (Kelvin) | 3000K, 4000K or 6000K |
| Light color | Warm white, neutral white or cool white |
| Luminous efficiency | 130 lm/w / 140 lm/w |
| Lumen | 4680 / 5040 |
| Beam angle | 120° |
| Color Rendering Index (CRI) | ≥0,80 |
| Operating Temperature | -20 °C to +50 °C |
| Storage Temperature | -30 °C to +60 °C |
| Working Humidity | 10-80% RH |
| Humidity Storage | 10-90% RH |

CAPABILITIES

| | |
|------------------|-----------|
| Housing material | Aluminium |
| Housing color | Black |
| Flicker-free | Yes |
| Dimmable | No |

LIFESPAN & WARRANTY

| | |
|----------|------------|
| Lifespan | 50.000 hrs |
| Warranty | 5 years |

DIMENSIONS & PACKAGING

| | |
|--------------------|-----------------|
| Product Dimensions | 595*595*35MM |
| Packing Dimensions | L645*W95*H645MM |
| Inner box | 2 pieces |
| Outer box | 8 pieces |

ADDITIONAL INFORMATION

| | |
|------------------|-----------|
| IP Rating | IP41 |
| LED Chip type | SMD2835 |
| Luminaires Class | Class III |
| Certificates | CE, ROHS |

AVAILABLE MODELS

| Color Temp | REF No |
|------------------------|--------|
| 3000K, 4000K, 6000K | 907460 |



DATA SHEET



LED BACK-LIT PANEL

60×60 BLACK FRAME 3CCT SWITCH

DIMENSIONS

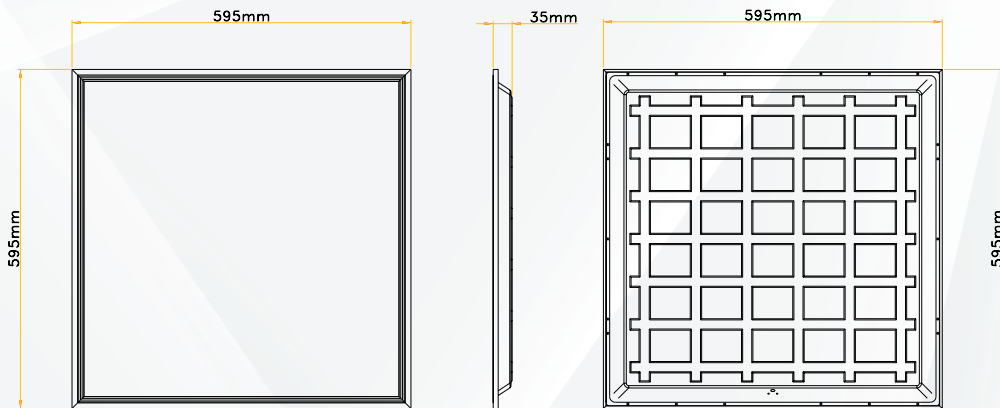

ADJUSTMENT DIAGRAM

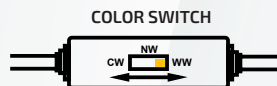
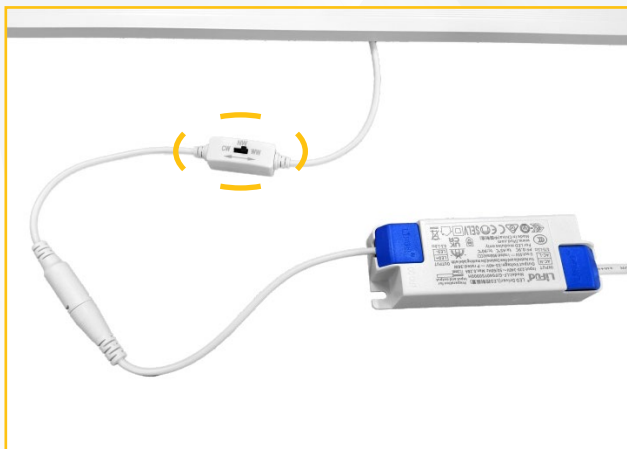

WW - 3000K

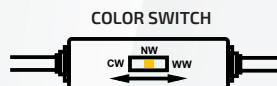

NW - 4000K

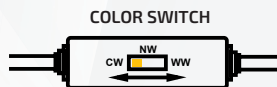

CW - 6000K

DATA SHEET

LED BACK-LIT PANEL

60×60 BLACK FRAME 3CCT SWITCH



TEST REPORT

3000K

LUMINOUS INTENSITY DISTRIBUTION DIAGRAM

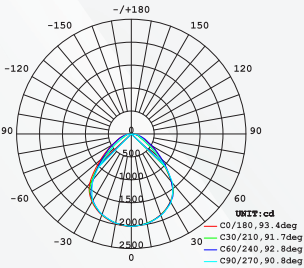

AVERAGE BEAM ANGLE (50%): 88.2 DEG

PLANAR ISOLUX DIAGRAM (UNIT: 1X)

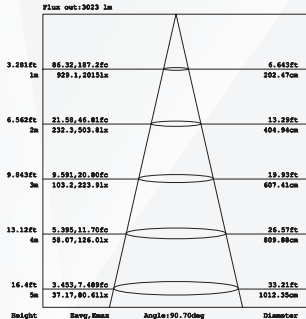
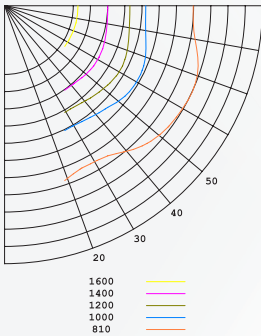

4000K

LUMINOUS INTENSITY DISTRIBUTION DIAGRAM

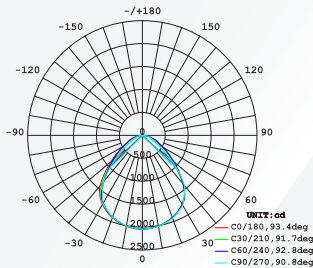

AVERAGE BEAM ANGLE (50%): 88.3 DEG

PLANAR ISOLUX DIAGRAM (UNIT: 1X)

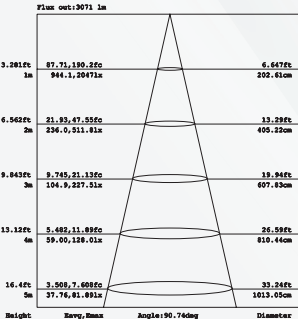
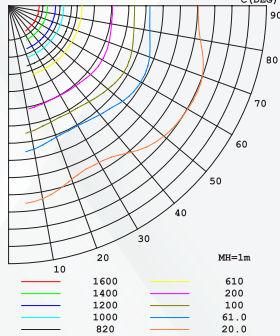

6000K

LUMINOUS INTENSITY DISTRIBUTION DIAGRAM

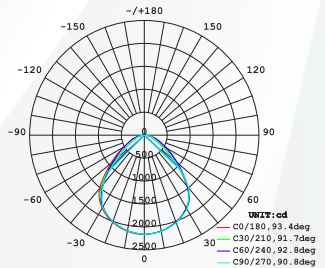

AVERAGE BEAM ANGLE (50%): 88.2 DEG

PLANAR ISOLUX DIAGRAM (UNIT: 1X)

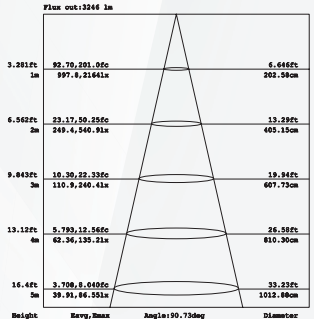
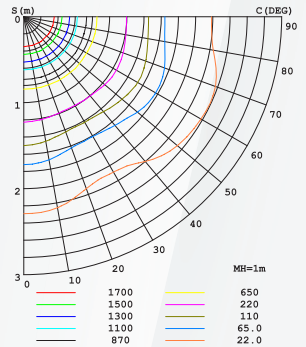

Note: The Curves indicate the illuminated area and the average illumination when the luminaire is at different distance.

DATA SHEET

LED BACK-LIT PANEL

60×60 BLACK FRAME 3CCT SWITCH

INSTALLATION INSTRUCTION

IN-BUILT

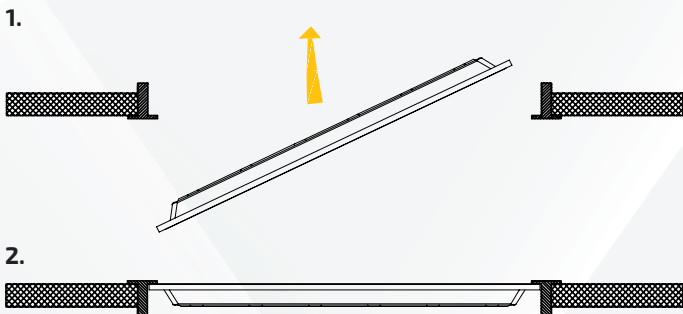

SUSPENDING

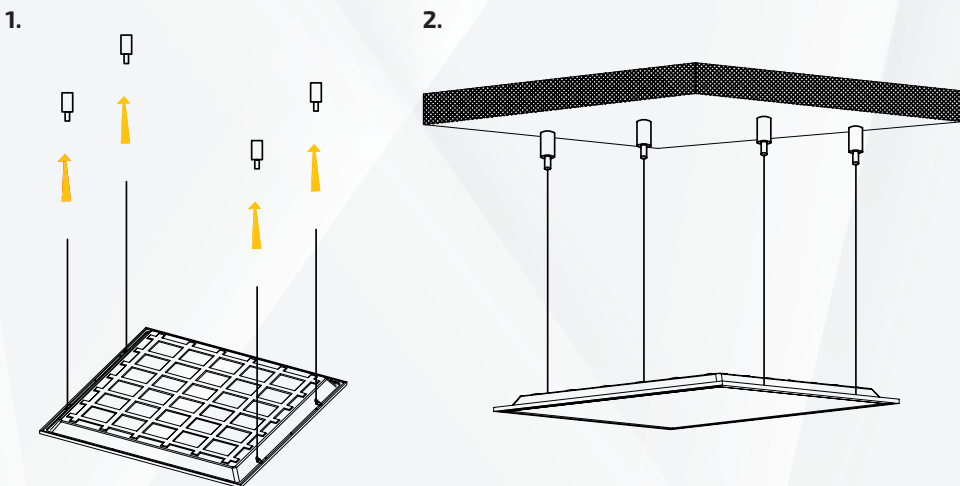

| MODEL | PRODUCT DIMENSION | HOLE SIZE(L1XL2) | PRODUCT DIMENSION | HOLE SIZE(L1XL2) |
|--------------------|-------------------|------------------|-------------------|------------------|
| SRPL30X120-28WH-BL | 595x595x35mm | 575x575mm | | |
| SRPL62X62-28WH-BL | 620x620x35mm | 600x600mm | | |
| SRPL60X60-28WH-BL | 595x595x35mm | 1175x275mm | | |

DATA SHEET

LED BACK-LIT PANEL

60×60 BLACK FRAME 3CCT SWITCH

INSTALLATION INSTRUCTION

MOUNTING

1.

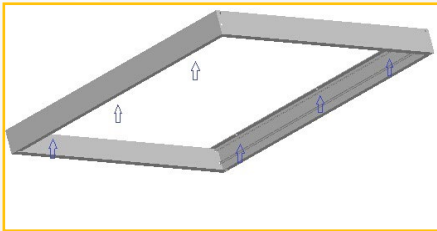

2.

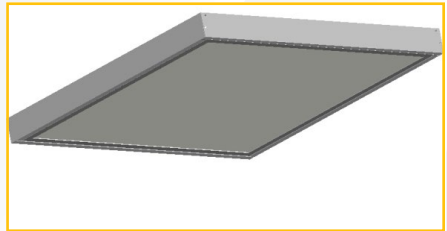

| MODEL | PRODUCT DIMENSION | HOLE SIZE(L1xL2) | PRODUCT DIMENSION | HOLE SIZE(L1xL2) |
|--------------------|-------------------|------------------|-------------------|------------------|
| SRPL30X120-28WH-BL | 595x595x35mm | 575x575mm | | |
| SRPL62X62-28WH-BL | 620x620x35mm | 600x600mm | | |
| SRPL60X60-28WH-BL | 595x595x35mm | 575x575mm | | |

SPRING

1.

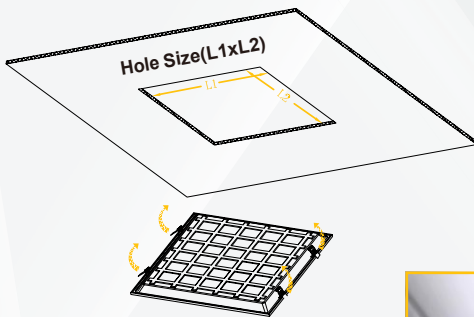

2.

